

3 级插头接触点位置尺寸

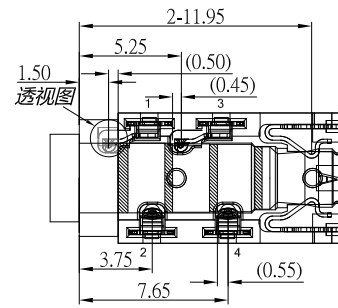

5 级插头接触点位置尺寸

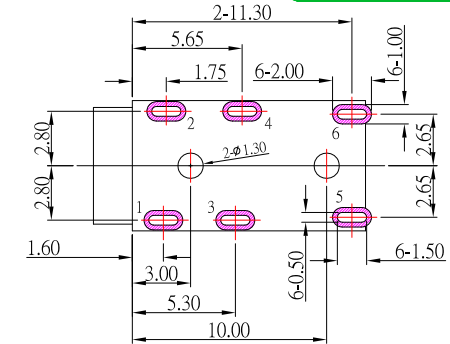

P.C.B LAYOUT

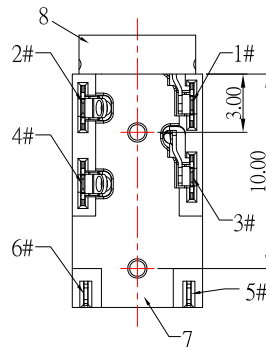
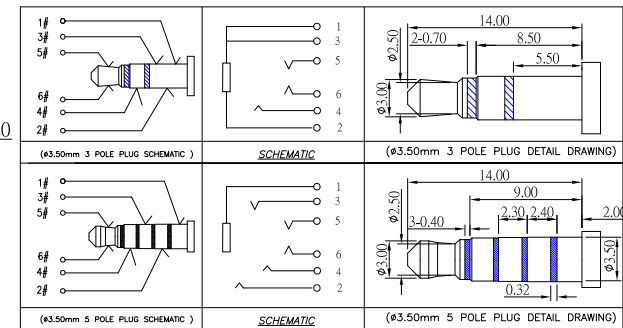
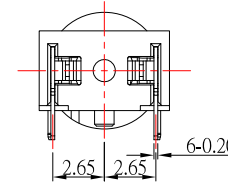
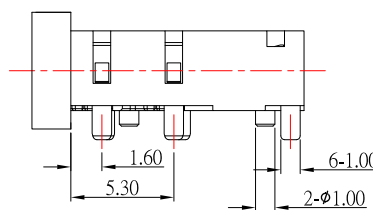
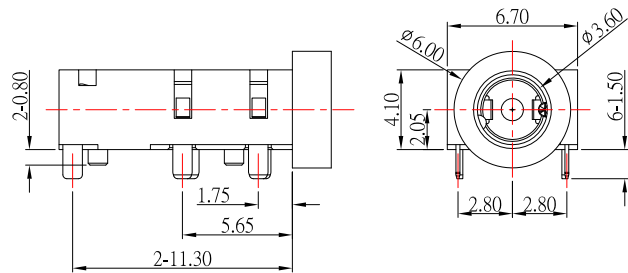

**SPECIFICATION**

1. Rating : 1.0A ;
2. Contact resistance :  $\leq 100m\Omega$  ;
3. Insulation resistance :  $\geq 100M\Omega$  ;
4. Withstand voltage : 500VAC ;
5. Insertion and extraction force : 3-30N;
6. life test : 5,000 cycles °

8	METAL BUSHING		C3604,GOLD FLASH
7	HOUSING	7	PA10T,COLOR BLACK.
6	TERMINAL 6#	7	STAINLESS STEEL; NICKEL UNDER PLATING OVERALL,GOLD FLASH PLATING ON SOLDER AREA ;GOLD FLASH PLATING ON CONTACT AREA
5	TERMINAL 5#	7	
4	TERMINAL 4#	7	
3	TERMINAL 3#	7	PHOSPHOR BRONZE; NICKEL UNDER PLATING OVERALL,GOLD FLASH PLATING ON SOLDER AREA ;GOLD FLASH PLATING ON CONTACT AREA
2	TERMINAL 2#	7	
1	TERMINAL 1#	7	
ITEM	NAME	Q'TY	DESCRIPTION



TOLERANCE UNLESS OTHERWISE STATED :  
 Up to 5 ±0.2  
 Above 5 ~ 15 ±0.3  
 Above 15 ~ 30 ±0.4  
 Above 30 ~ 50 ±0.5  
 Angle ±0.3°

3RD. ANGEL'S



UNITS MM

DRAWN BY:	DATE	MAT'L	TITLE	JACK
Jack Lu	07/11/22			
CHECKED BY:	DATE	FINISH	MODLE	PHONE JACK
Jacky Chen	07/11/22			
APPROVED BY:	DATE	SCALE	DWG NO.	PJ-T53063-S214
Tony Kao	07/11/22	1 : 1		
		SHEET NO.	PART NO.	PJ-T53063-S214
		1 of 1		
			SIZE	A4
			VER	R1

1	更新材質	Jack	071122
ITEM NO.	DESCRIPTION	DRAWN	DATE