

DATE CODE:
YYMMDD
YY:YEAR(15-)
MM:MONTH(01-12)
DD:DAY(01-31)

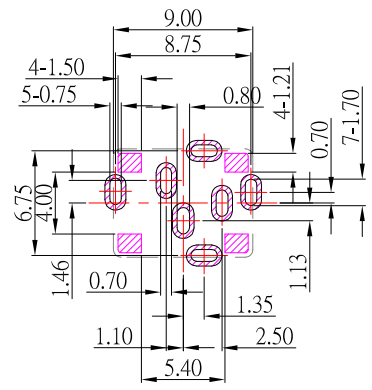

P.C.B LAYOUT
TOP VIEW

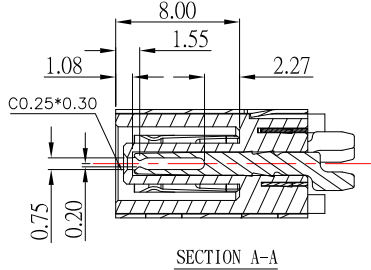
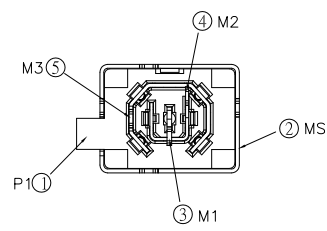
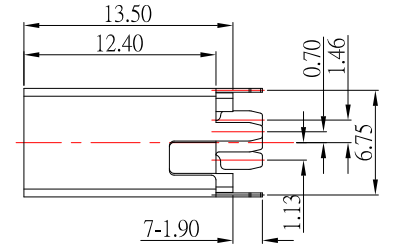
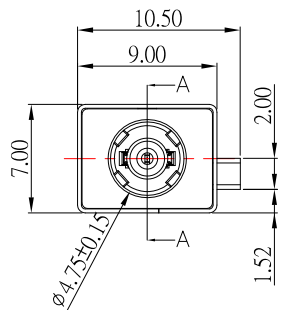
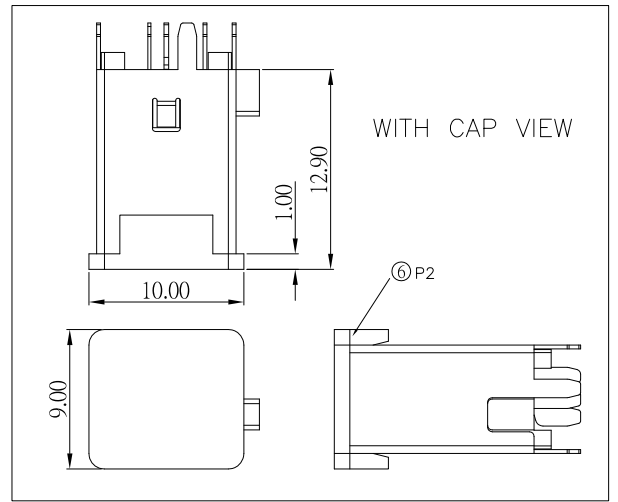

SCHEMATIC	
	M2 (SPRING PIN)
	M1 (SIGNAL PIN)
	M3 (SPRING PIN)

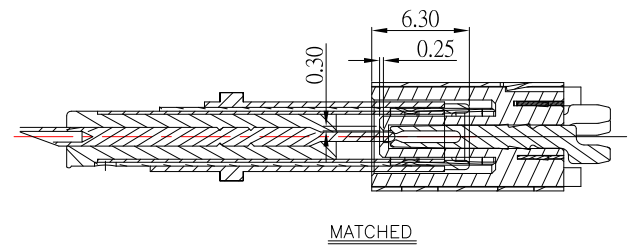
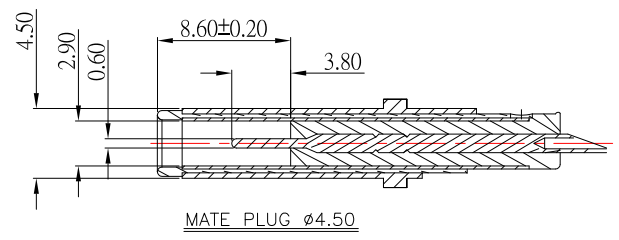

SPECIFICATION

- 1.Rating : DC 30V, 8.0A
- 2.Contact resistance : $\leq 30m\Omega$
- 3.Insulation resistance : $\geq 100M\Omega$
- 4.Withstand voltage : 500VAC
- 5.Insertion and extraction force : 2-30N
- 6.life test : 5,000 cycles

NO.	DESCRIPTION	QTY	MATERIAL	PLATING
⑥	CAP	1	PA10T	
⑤	M3 SPRING	1	PHOSPHOR BRONZE	Au+Ni-Plating
④	M2 SPRING	1	PHOSPHOR BRONZE	Au+Ni-Plating
③	M1 SIGNAL	1	PHOSPHOR BRONZE	Au+Ni-Plating
②	SHELL	1	SUS	Ni-Plating
①	HOUSING	1	PA10T	

東莞市高迪電子有限公司
DONG GUAN GAO DI ELECTRONICS CO., LTD

TOLERANCE UNLESS OTHERWISE STATED :
 Up to 5 ±0.2
 Above 5 ~ 15 ±0.3
 Above 15 ~ 30 ±0.4
 Above 30 ~ 50 ±0.5
 Angle ±0.3

3RD. ANGEL'S

UNITS MM

DRAWN BY:	DATE	MAT'L	TITLE	JACK
Jack Lu	10/31/19		MODLE	DC JACK
CHECKED BY:	DATE	SCALE	DWG NO.	DC-D287AVH-0.6-S214
Jacky Chen	10/31/19	1 : 1	PART NO.	DC-D287AVH-0.6-S214
APPROVED BY:	DATE	SHEET NO.		
Tony Kao	10/31/19	1 of 1		

ITEM NO.	DESCRIPTION	DRAWN	DATE