

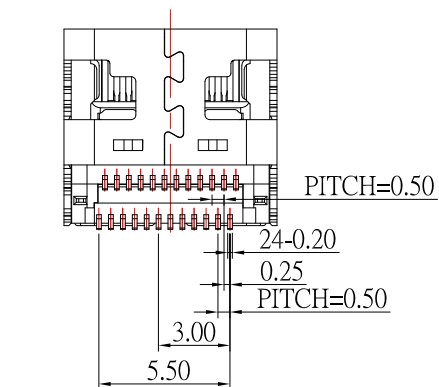

SBC-240S34H-45x-S331

鍍層厚度

1: 3u"
2: 15u"
3: 30u"

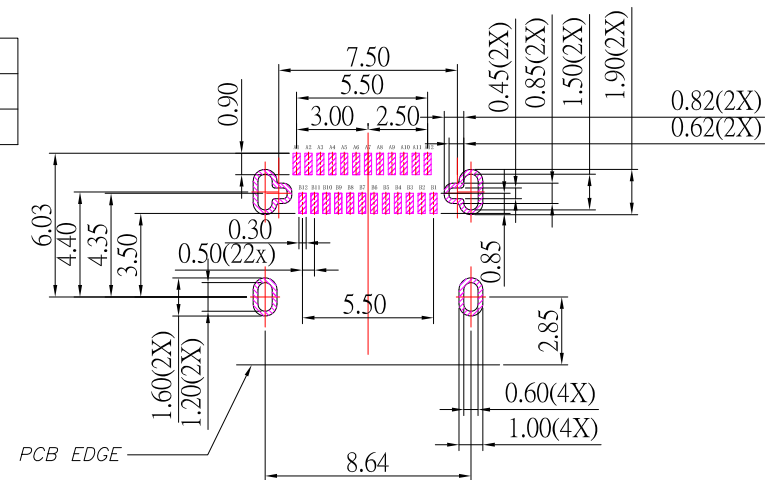
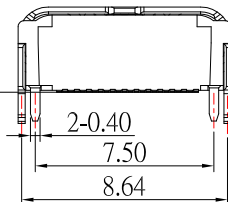
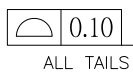
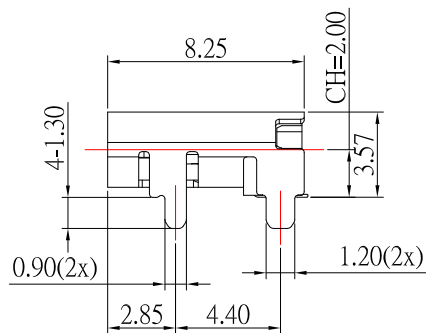
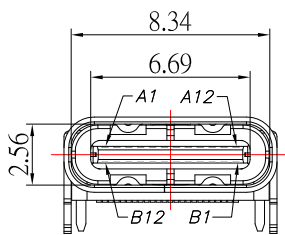
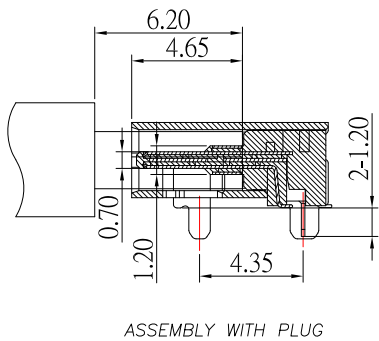
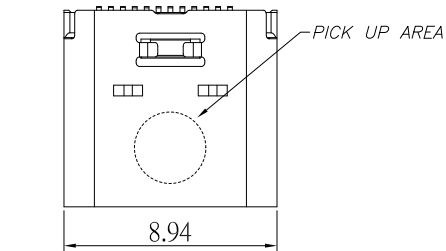

USB TYPE-C PIN ASSIGNMENTS

PIN NUMBER	SIGNAL NAME	PIN NUMBER	SIGNAL NAME
A1	GND	B12	GND
A2	TXp1	B11	RXp1
A3	TXn1	B10	RXn1
A4	VBUS	B9	VBUS
A5	CC1	B8	SBU2
A6	Dp1	B7	Dn2
A7	Dn1	B6	Dp2
A8	SBU1	B5	CC2
A9	VBUS	B4	VBUS
A10	RXn2	B3	TXn2
A11	RXp2	B2	TXp2
A12	GND	B1	GND

SPECIFICATIONS

Electrical:

- Rating: 5.0V , 5.0A
- Contact Resistance: 40 mΩ Max
- Insulation Resistance: 100 MΩ Min
- Dielectric Withstanding Voltage: 100V AC

Mechanical:

- Connector Mate and Unmate Force
 - Mate force: 5~20 N
 - Unmate force: 8~20 N

Material:

- Housing: PA9T
- Contact: C1815
- Shell: SUS

Finish:

- Contact: Plated Gold in Mating Area ;
Gold Plated on Solder Balls ;
Nickel under plated overall
- Shell: Nickel under Plated surface layer



TOLERANCE UNLESS OTHERWISE STATED:
 Up to 5 ±0.2
 Above 5 ~ 15 ±0.3
 Above 15 ~ 30 ±0.4
 Above 30 ~ 50 ±0.5
 Angle ±0.3°

3RD. ANGEL'S

UNITS MM

DRAWN BY:	DATE	MAT'L	TITLE	CONNECTOR
Jack Lu	03/16/23			
CHECKED BY:	DATE	FINISH	MODLE	USB4.0 TYPE CF 外殼四腳插板 板上雙排 SMT L8.25 GEN 3X2 高導電銅
Jacky Chen	03/16/23			
APPROVED BY:	DATE	SCALE	DWG NO.	SBC-240S34H-45x-S331
Tony Kao	03/16/23	1 : 1	PART NO.	SBC-240S34H-45x-S331
		SHEET NO.	1 of 1	
				SIZE A4
				VER R1

1	更新料號	Jack	031623
ITEM NO.	DESCRIPTION	DRAWN	DATE