

|         |     |
|---------|-----|
| RELEASE | 4.8 |
| LOCK    | 3.4 |

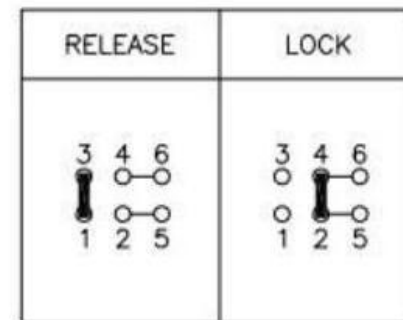

SCHEMATIC (NON-SHORTING)

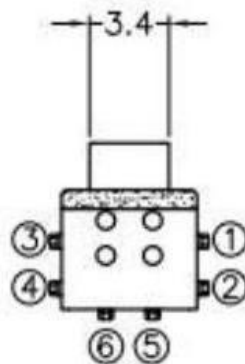
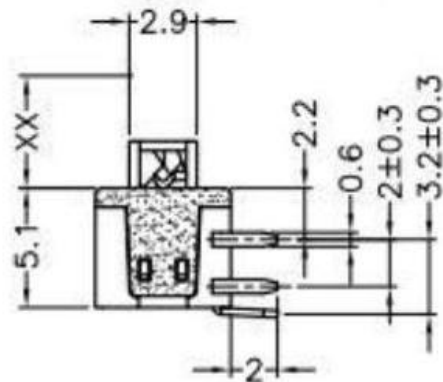
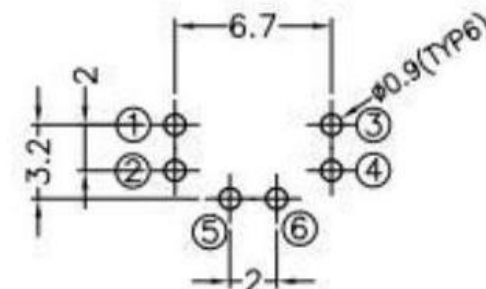
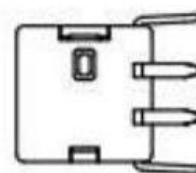
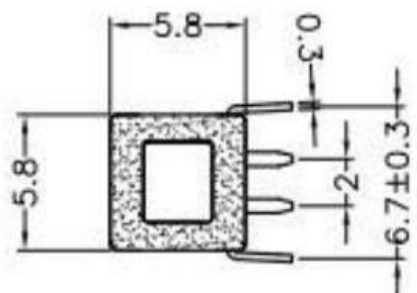
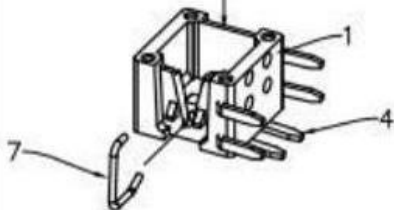
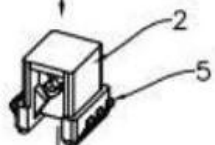
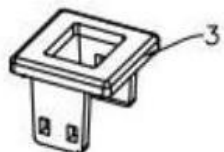

P.C.B LAYOUT MOUNTING PATTERN

| SPECIFICATION                 |               |
|-------------------------------|---------------|
| 1.环境温度(Operating Temp)        | -20℃~+80℃     |
| 2.相对湿度(Working Humidity)      | 5%~35%        |
| 3.额定规格(Rated Value)           | DC50V/30mA    |
| 4.接触电阻(Contact Resistance)    | 100mΩ max     |
| 5.绝缘电阻(Insulation Resistance) | 100MΩ min     |
| 6.耐电压(Withstand Voltage)      | 250Vac/60S    |
| 7.动作力(Operating Force)        | 300±50gf      |
| 8.使用寿命(Operating Life)        | 100,000 cycle |



东莞市高迪电子有限公司

Dong Guan KDRR Electronic Switch Jack Co., Ltd.

TOLERANCE UNLESS OTHERWISE STATED:

Up to 5 ±0.2  
Above 5 - 15 ±0.3  
Above 15 - 30 ±0.4  
Above 30 - 50 ±0.5  
Angle ±0.3°

3RD. ANGEL'S



UNITS

MM

|              |          |
|--------------|----------|
| DRAWN BY:    | DATE     |
| Jack Lu      | 01/06/15 |
| CHECKED BY:  | DATE     |
| Jacky Chen   | 01/06/15 |
| APPROVED BY: | DATE     |
| Tony Kao     | 01/06/15 |

|           |        |             |
|-----------|--------|-------------|
| MAT'L     | TITLE  | SWITCH      |
| FINISH    | MODLE  | PUSH SWITCH |
| SCALE     | 1:1    | DWG NO.     |
| SHEET NO. | 1 of 1 | PART NO.    |
|           |        | SIZE        |
|           |        | A4          |
|           |        | VER         |
|           |        | R1          |

| ITEM NO. | DESCRIPTION          | DRAWN    | DATE   |
|----------|----------------------|----------|--------|
| 2        | 更新Contact Resistance | Jack     | 010615 |
| 1        | Rating Update        | Frank Wu | 030212 |