

CAD FILE:

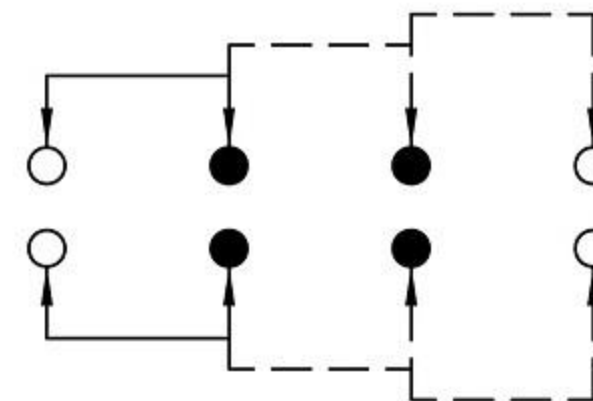

SCHEMATIC (SHORTING)

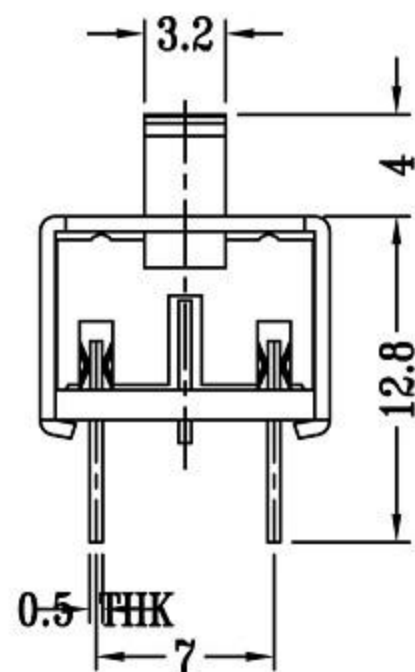
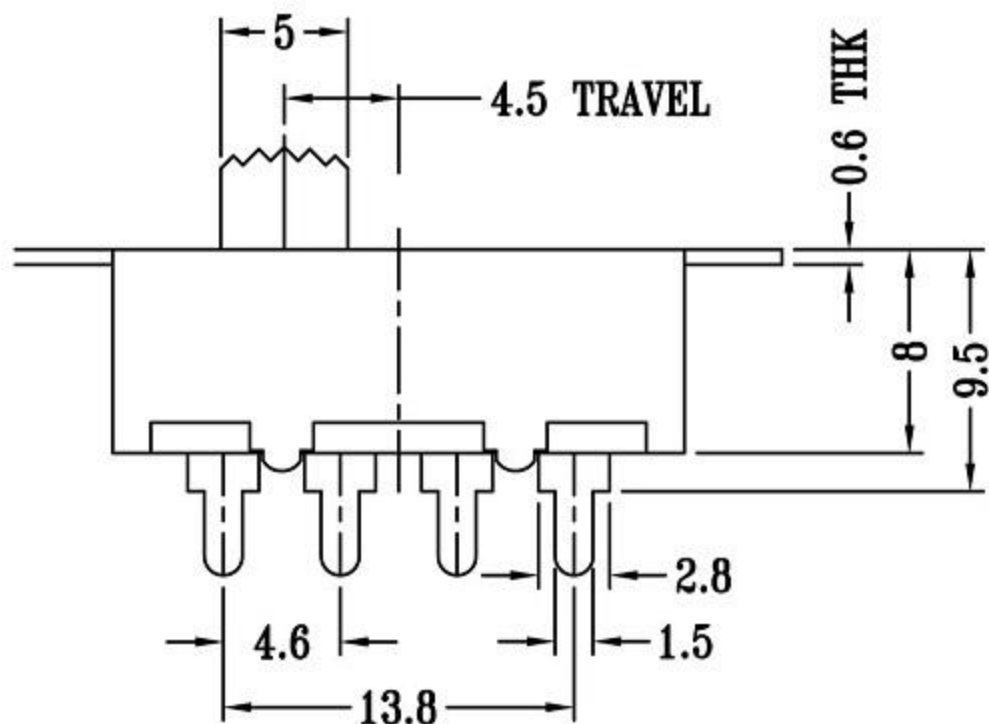
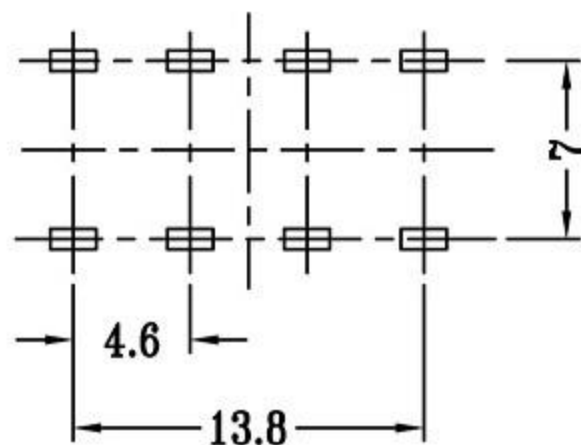
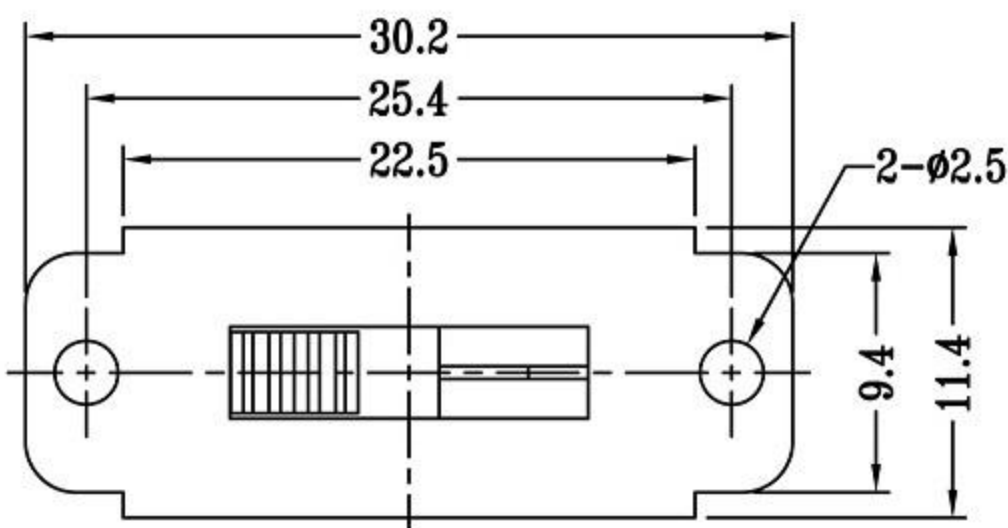

P.C.B LAYOUT
BOTTOM VIEW

拨动开关立式技术参数:

1. 额定负荷: AC 125V 250V 3A 6A 10A
2. 接触阻抗: $\leq 50m\Omega$
3. 绝缘阻抗: $\geq 100m\Omega$ DC500V
4. 耐焊温度: $250 \pm 5^\circ$ 5s
5. 使用寿命: 10,000 cycles
6. 使用温度: -25°C to 80°C
7. 使用湿度: $\leq 85\%$ RH
8. 操作力: 160gf 256gf 300gf 可定制
9. 手柄长度: 2mm-10mm 可定制

注: "*"表示关键尺寸(6个)

NO.	PARTS	MATERIALS	Q'TY	FINISH	TOLERANCE UNLESS SPECIFIED			
8								
7	STEEL BALL	STEEL	1	NATURAL				
6	SPRING	STEEL WIRE	1	NATURAL				
5	CONTACT CLIP	PBS STRIP	2	Ag PLATED	WITHIN OVER	A	2012-10-28	初版
4	TERMINAL	BRASS STRIP	8	Ag PLATED		ISSUE	DATE	DESCRIPTIONS OF REVISION
3	BASE	PHENOLIC RESIN	1	NATURAL	TITLE : VERTICAL SLIDE SWITCH		UNIT : mm	DRWG NO.:
2	FRAME	STEEL STRIP	1	Ni PLATED	MODEL:		SCALE: 3:1	DWN.
1	KNOB	POM	1	BLACK	东莞市高迪电子有限公司			2012-10-26
								APPD.