

技术要求:

1. 开关外观无划伤, 端子无受损、发黄现象;
2. 开关换向清晰;
3. 不使用一级有害物质;
4. 标注 ▲号为重点管控尺寸;
5. 未注公差参照图面图框公差标准;
6. 开关寿命: 1, 000, 000 次

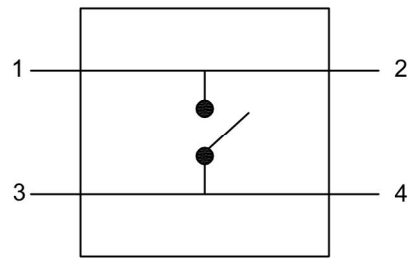
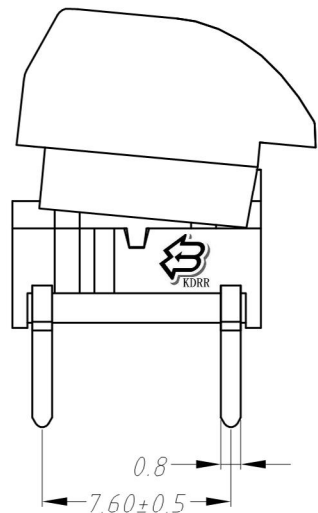

SCHMATIC

PCB LAYOUT

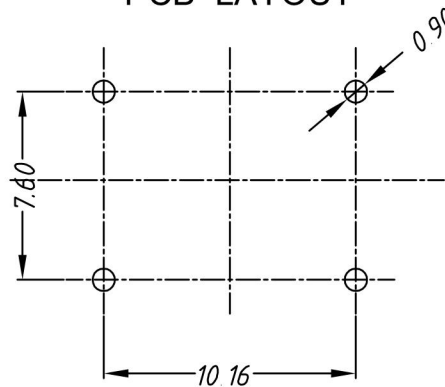

SPECIFICATIONS

Rating	DC 12V 50 mA Max.
Contact Resistance	500 mΩ Max.
Insulation Resistance	100 V DC , 100 MΩ Min.
Operating Temperature	-20°C ~ +70°C
Operating Force	160 ± 50gf
Operating Life (cycles)	100,000

NO.	PART NAME	QTY	MATERIAL	SPECIAL DEAL
1	BRACKET	1	LCP	WHITE
2	BASE FRAME	1	LCP	WHITE
	TERMINAL	1	PHOSPHOR BRONZE	SILVER PLATING
3	SPRING PLATE	1	STAINLESS STEEL	SILVER PLATING
4	ACTUATOR	1	PA6T	WHITE
5	FRAME	1	STAINLESS STEEL	TIN PLATING
	LED	1		



东莞市高迪电子有限公司

Dong Guan KDRR Electronic Switch Jack Co., Ltd.

DRAWN BY: Ming Ming Zou DATE 11/19/14

CHECKED BY: Ning Ning Su DATE 11/19/14

APPROVED BY: Jia Xiang DATE 11/19/14

MAT'L		TITLE	SWITCH
FINISH		MODLE	TACT SWITCH
SCALE	1 : 1	DWG. NO.	GD-TS-10-C
SHEET NO.	1 of 1	PART NO.	
		SIZE	A4
		VER	R2

TOLERANCE UNLESS OTHERWISE STATED:
 Up to 5 ±0.2
 Above 5 ~ 15 ±0.3
 Above 15 ~ 30 ±0.4
 Above 30 ~ 50 ±0.5
 Angle ±0.3

3RD. ANGEL'S



UNITS MM

ITEM NO.	DESCRIPTION	DRAWN	DATE
2	更新料號	Jack	112618
1	新增材質表	Jack	092818

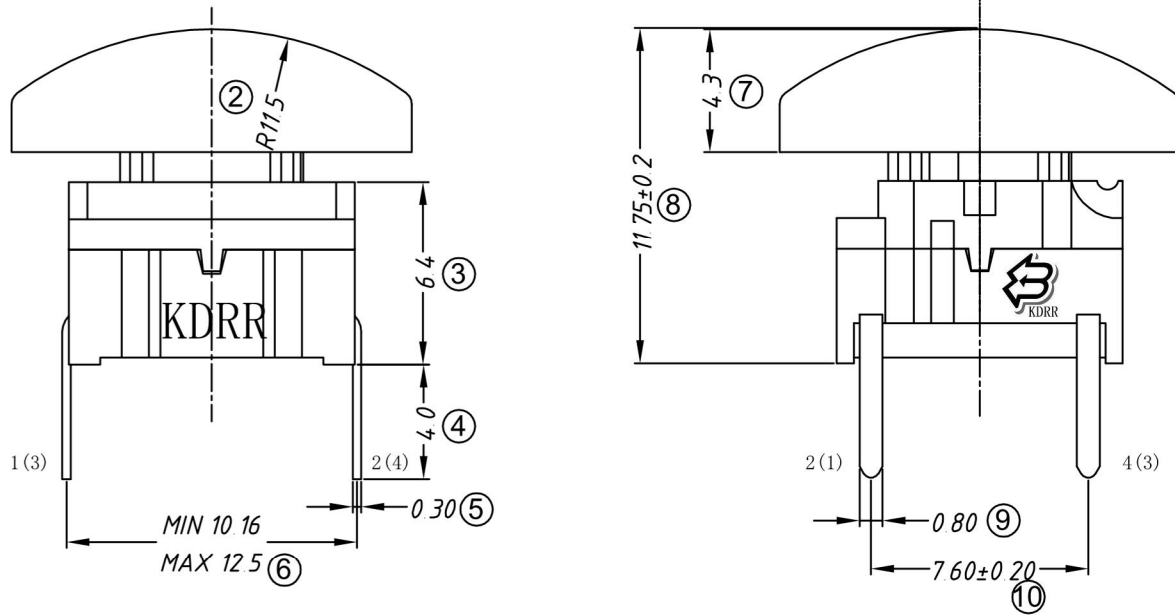

SCHMATIC

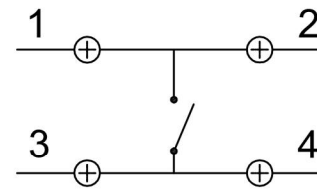

技术要求:

1. 开关防水等级: IP67;
2. 开关寿命: >10, 000, 000;
3. 开关符合ROHS标准。

PCB LAYOUT

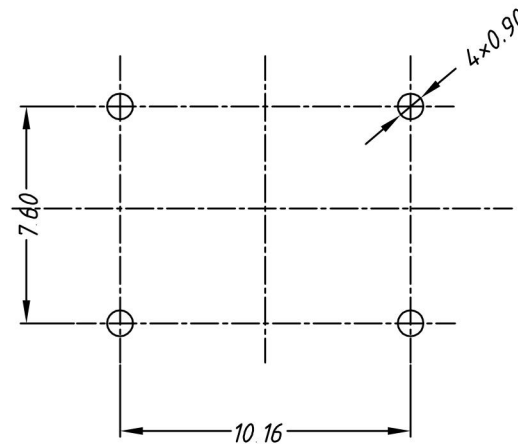
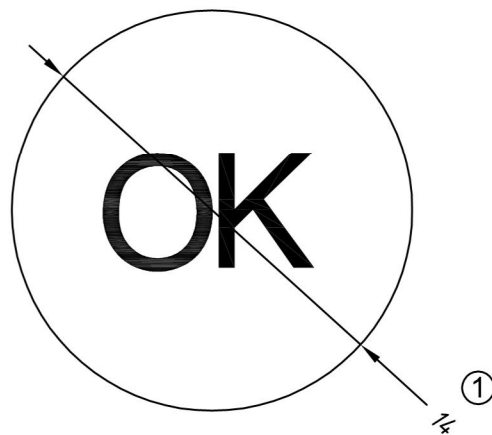

SPECIFICATIONS

Rating	DC 12V 50 mA Max.
Contact Resistance	500 mΩ Max.
Insulation Resistance	100 V DC , 100 MΩ Min.
Operating Temperature	-20°C ~ +70°C
Operating Force	160 ± 50gf
Operating Life (cycles)	100,000

NO.	PART NAME	QTY	MATERIAL	SPECIAL DEAL
1	BRACKET	1	LCP	WHITE
2	BASE FRAME	1	LCP	WHITE
	TERMINAL	1	PHOSPHOR BRONZE	SILVER PLATING
3	SPRING PLATE	1	STAINLESS STEEL	SILVER PLATING
4	ACTUATOR	1	PA6T	WHITE
5	FRAME	1	STAINLESS STEEL	TIN PLATING
	LED	1		

ITEM NO.	DESCRIPTION	DRAWN	DATE
2	更新料號	Jack	112618
1	新增材質表	Jack	092818

东莞市高迪电子有限公司
 Dong Guan KDRR Electronic Switch Jack Co., Ltd.

TOLERANCE UNLESS OTHERWISE STATED:
 Up to 5 ±0.2
 Above 5 ~ 15 ±0.3
 Above 15 ~ 30 ±0.4
 Above 30 ~ 50 ±0.5
 Angle ±0.3°

3RD. ANGEL'S

 UNITS MM

DRAWN BY:	DATE
Ming Ming Zou	11/19/14
CHECKED BY:	DATE
Ning Ning Su	11/19/14
APPROVED BY:	DATE
Jia Xiang	11/19/14

MAT'L		TITLE	SWITCH
FINISH		MODLE	TACT SWITCH
SCALE	1 : 1	DWG. NO.	GD-TS-10D-F
SHEET NO.	1 of 1	PART NO.	
		SIZE	A4
		VER	R2