

REV.	ECN NO.	DESCRIPTION	DESIGN	DATE
A		INITIAL	Kai	2018.06.14

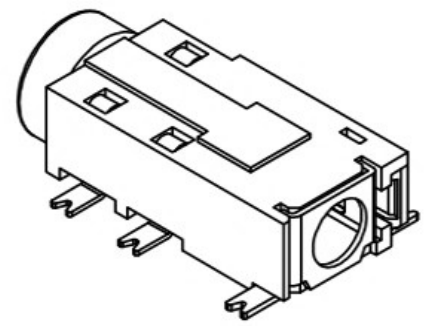

3D VIEW

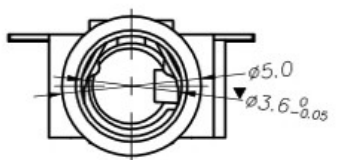
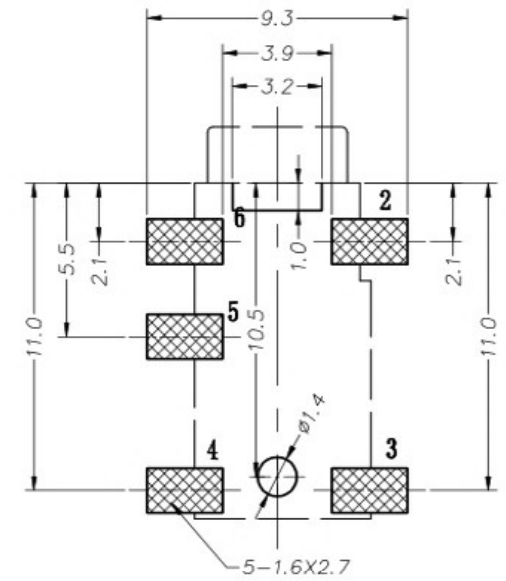
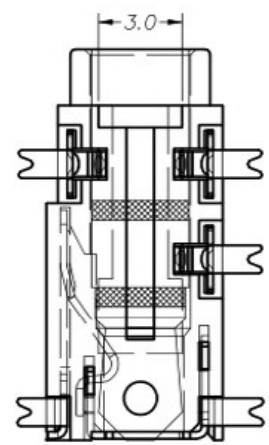
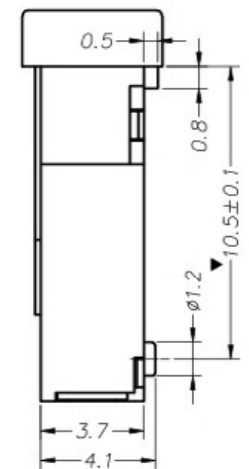
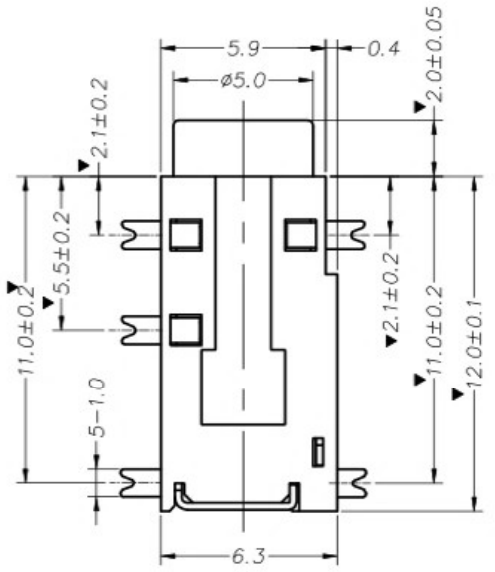

P.C.B LAYOUT TOP VIEW

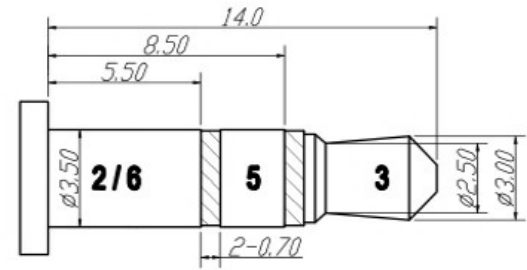
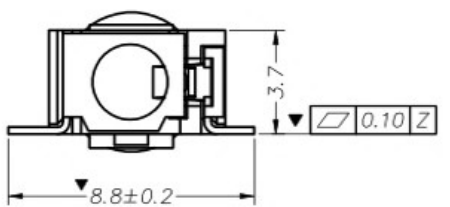

3.5 PLUG SPEC

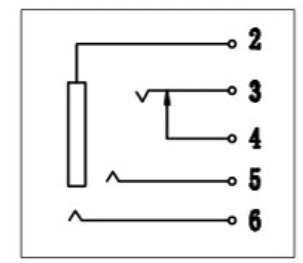

SCHEMATIC

4	04	盖脚	1	磷铜	0.25T	镀银
3	03	弹片脚	1	镀青铜	0.2T	镀银
2	02	中脚	3	磷铜	0.2T	镀银
1	01	底座	1	PPA		黑色
序号	产品编号	产品名称	数量	材料	规格	电镀

主要技术性能	
额定负荷	DC 30V/0.5A
接触电阻	≤0.03Ω
绝缘电阻	≥100MΩ
耐压	AC500V (50Hz)/min
插拔力	3-20N
使用温度范围	-30-70℃
使用寿命	5000次

UNLESS OTHERWISE SPECIFIED TOLERANCES			
DECIMALS:		ANGLES:	
DIM	TOL	DIM	TOL
X.	±0.35	X.	±2°
X.X	±0.30	X.X	±1°
X.XX	±0.20	X.XX	—
X.XXX	±0.10	X.XXX	—

东莞市高迪电子有限公司

DWG NO.	Q/XM-CP-RD-XXXX	PART NAME:	PHONE JACK
DESIGN:	Kai	PART NO.	
CHECK:	Lucky	2018.06.14	
APPROVED:	Lucky	2018.06.14	

REV.	UNIT:	SHEET:	
A	mm	1/1	

由 Autodesk 教育版产品制作

由 Autodesk 教育版产品制作