

| REV | ECN No. | DESCRIPTION | DESIGN | DATE |
|-----|---------|-------------|--------|------------|
| A | - | NEW RELEASE | 蒋建银 | 2018.01.08 |

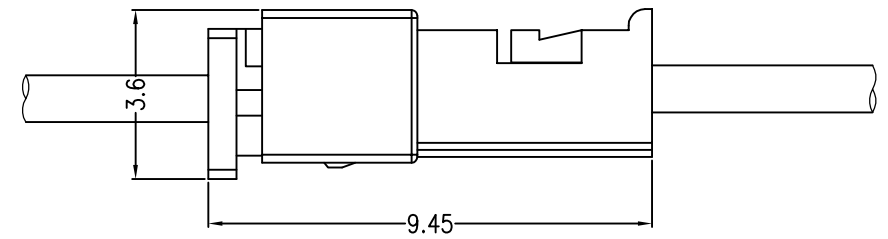
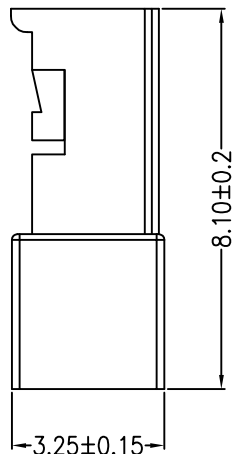
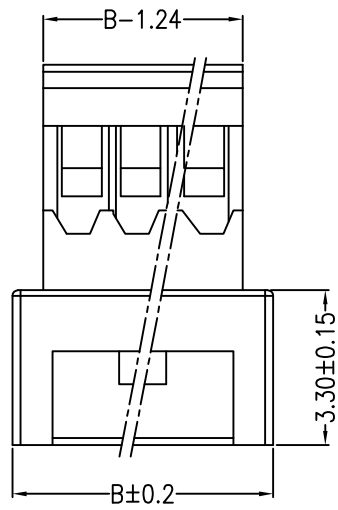

Assembly Layout

主要技术参数 Main Specifications

- 线数 (Poles): 02 to 16
- 接触电阻 (Contact resistance): $\leq 20m\Omega$
- 绝缘电阻 (Insulation resistance): $\geq 100M\Omega$
- 额定电压 (Rated voltage): 125 V AC DC
- 额定电流 (Rated current): 1.0A AC DC
- 耐电压 (Withstand Voltage): 500V AC/minute
- 温度范围 (Temperature Range): $-25^{\circ}C \sim +105^{\circ}C$

ORDER INFORMATION:

C1251R--A5W-P**

| | | | |
|------------------|-----------------|-------------------|------------------|
| PART No.: | C1251R-**-A5W-P | PACKAGING: | P=PE |
| No. OF CIRCUITS: | ** | PLASTIC MATERIAL: | A5W=PA66 (WHITE) |

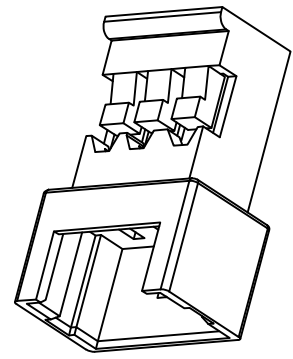
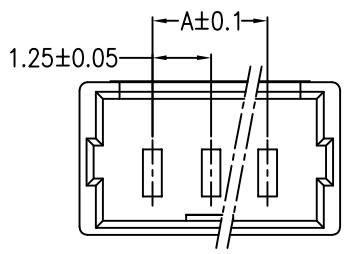

| Circuits | Dimensions (mm) | |
|----------|-----------------|-------|
| | A | B |
| 02 | 1.25 | 4.20 |
| 03 | 2.50 | 5.45 |
| 04 | 3.75 | 6.70 |
| 05 | 5.00 | 7.95 |
| 06 | 6.25 | 9.20 |
| 07 | 7.50 | 10.45 |
| 08 | 8.75 | 11.70 |
| 09 | 10.00 | 12.95 |
| 10 | 11.25 | 14.20 |
| 11 | 12.50 | 15.45 |
| 12 | 13.75 | 16.70 |
| 13 | 15.00 | 17.95 |
| 14 | 16.25 | 19.20 |
| 15 | 17.50 | 20.45 |
| 16 | 18.75 | 21.70 |

| ITEM | COMPONENT | Q'TY | MATERIAL | FINISH |
|------|-----------|----------|----------|-------------|
| C | | | | |
| B | | | | |
| A | HOUSING | 1~16 PCS | PA66 | COLOR:WHITE |

東莞市高迪電子有限公司
DONG GUAN GAO DI ELECTRONICS CO., LTD

TITLE: C1251R
1.25mm PITCH Housing

| | | | |
|-----------|------|-------|----------|
| .X±0.35 | X.± | USE: | CUSTOMER |
| .XX±0.25 | .X± | APPD: | 邵敬和 |
| .XXX±0.15 | .XX± | CHKD: | 田峰 |
| -- | -- | DR: | 蒋建银 |

| | |
|-----------|-----------------|
| PART NO.: | C1251R-**-A5W-P |
| DWG NO.: | GCCP-0592 |
| SCALE | SHEET |
| 1 : 1 | 1 / 1 |

| REV | ECN No. | DESCRIPTION | DESIGN | DATE |
|-----|---------|-------------|--------|------------|
| A0 | | Release | 蒋建银 | 2018.05.24 |
| | | | | |

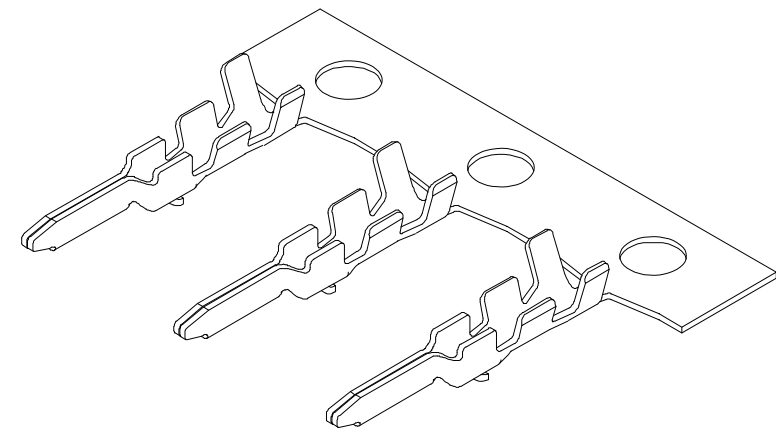
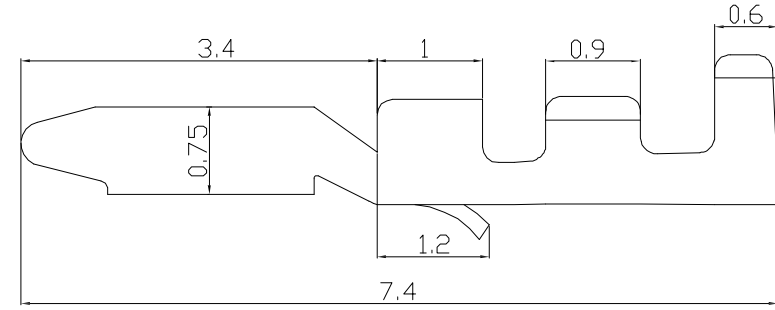
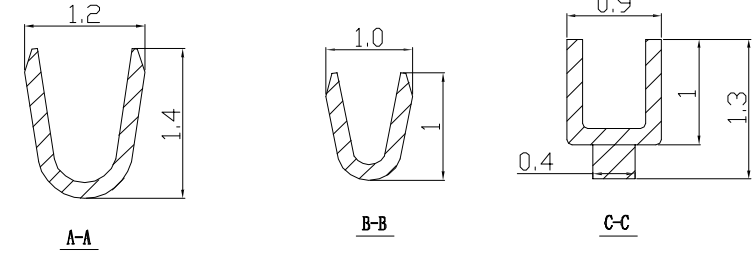
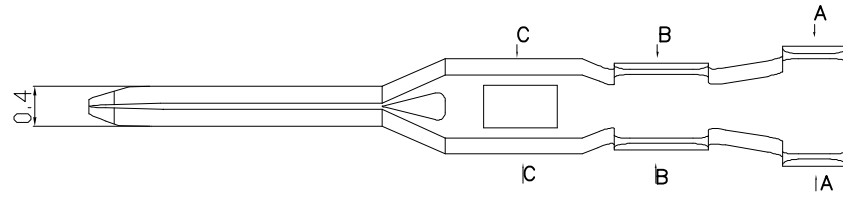

Ordering Information & Specification:

| Part No | Wire Range | Insulation O.D. | Material | Finish | Qty/Reel |
|-----------|-------------|-----------------|-----------------|-----------|-----------|
| C1251RT端子 | AWG #32~#28 | 1.0mm(MAX) | Phosphor bronze | Sn-plated | 15000 pcs |

| | | | |
|---|------------|-------------------|-------------------------|
| 東莞市高迪電子有限公司 DONG GUAN GAO DI ELECTRONICS CO., LTD | | TITLE: 1.25空中对接端子 | |
| X.±0.1 | X.±1' | USE: MANUFACTURE | PART NO.: C1251RT-02端子 |
| .XX±0.05 | .XX±0.5' | APPD: 谭龙清 | DWG NO.: JKUN-GCDZ-0022 |
| .XX±0.01 | .XX±0.1' | CHKD: 田峰 | SCALE: 1 : 1 |
| .XXX±0.005 | .XXX±0.05' | DR: 蒋建银 | SHEET: 1 / 1 |
| UNITS: mm | | | |